

## General Description

The AAT2848 is a tri-mode charge pump optimized for systems operating with lithium-ion/polymer batteries. The charge pump provides power for both white LED backlight and flash, with an integrated four channel backlight LED current sink plus two channel flash LED current sinks.

Each backlight channel can drive up to 30mA, while each flash current sink/channel can drive up to 300mA (600mA total). Two independent S<sup>2</sup>Cwire™ (AnalogicTech’s Simple Serial Control™) serial digital interface inputs enable, disable, and set LED current to one of 32 levels for the backlight and to one of 16 levels for the flash, with full-scale current independently set for backlight and flash using external resistors.

The AAT2848 offers a built-in fade-in/out function for linear control of the backlight current during ON/OFF transitions. The fade time is programmable by an external capacitor.

The AAT2848 also offers a built-in flash timeout function as a safety feature associated with the high power flash driver. The safety timer is also programmable via an external capacitor.

The AAT2848 is equipped with built-in short-circuit and over-temperature protection. The soft-start circuitry prevents excessive inrush current at start-up and mode transitions. The AAT2848 is available in a Pb-free, space saving TQFN33-20 package and operates over the -40°C to +85°C ambient temperature range.

## Features

- Tri-Mode (1x/1.5x/2x) Charge Pump
- Four 30mA Backlight LED Channels
- Independent S<sup>2</sup>Cwire Control for Backlight
- 32-Level Programmable Backlight Current Control—Linear, Inverting
- Two 300mA Flash LED Channels
- Independent S<sup>2</sup>Cwire Control for Flash
- 16-Level Programmable Flash Current Control—Linear, Inverting
- User-Programmable Full Scale Current for Backlight and Flash
- User-Programmable Fade-In/Fade-Out Function for Backlight
- User-Programmable Safety Timer for Flash LED Protection
- Built-In Thermal Protection
- Automatic Soft-Start
- -40°C to +85°C Temperature Range
- Available in TQFN33-20 Package

## Applications

- Camera Enabled Mobile Devices
- Digital Still Cameras
- Multimedia Mobile Phones

## Typical Application

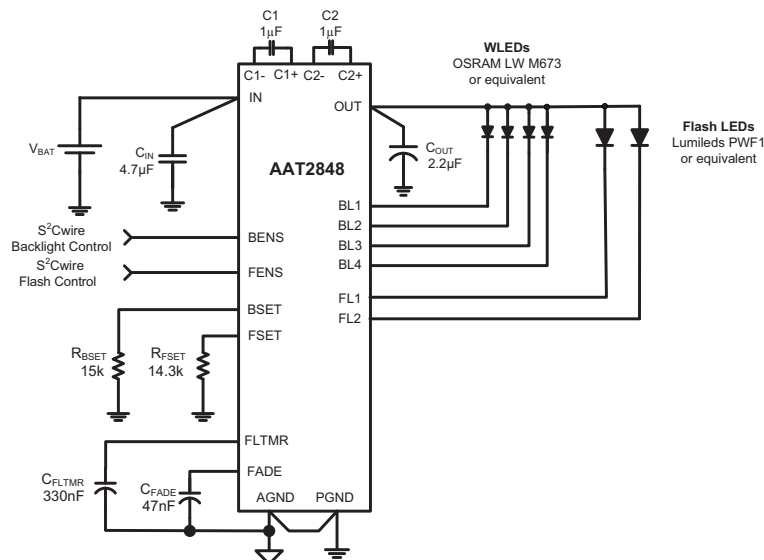

## Pin Descriptions

Pin #	Symbol	Description
1	OUT	Charge pump output; supplies current to the backlight and flash LEDs. Connect the backlight and flash LED anodes to OUT. Bypass OUT to PGND with a 2.2μF or larger ceramic capacitor as close to the AAT2848 as possible.
2	C2+	Positive terminal of charge pump capacitor 2. Connect a 1μF charge pump capacitor 1 from C2+ to C2-.
3	AGND	Analog ground. Connect AGND to PGND at a single point as close to the AAT2848 as possible.
4	FADE	Fade-In/Fade-Out timing control capacitor input. Connect a capacitor from FADE to AGND to set the automatic backlight current fade-in/fade-out response time. A 47nF capacitor sets the fade-in/fade-out backlight response time to 2.7 seconds. Connect to the IN pin to disable fade functionality.
5	FLTMR	Flash timer control capacitor input. Connect a capacitor from FLTMR to AGND to set the flash timer. A 330nF capacitor sets the flash timer to 1.3 seconds. Connect to the AGND pin to disable timer functionality.
6	BENS	Backlight enable and serial control input. BENS is the on/off control for the backlight and the S <sup>2</sup> Cwire input to serially control the backlight LED brightness relative to the maximum current set by the resistor at BSET.
7	FENS	Flash enable and serial control input. FENS is the on/off control for the flash and the S <sup>2</sup> Cwire input to serially control the flash LED brightness relative to the maximum current set by the resistor at FSET.
8	FSET	Flash current setting input. A 9.53kΩ resistor from FSET to AGND sets the maximum flash LED current to 300mA per flash output.
9	BSET	Backlight current setting input. A 10kΩ resistor from BSET to AGND sets the maximum backlight LED current to 30mA per backlight output.
10	BL1	Backlight LED 1 current sink/channel. BL1 controls the current through backlight LED 1. Connect the cathode of backlight LED 1 to BL1. If not used, connect BL1 to OUT.
11	BL2	Backlight LED 2 current sink/channel. BL2 controls the current through backlight LED 2. Connect the cathode of backlight LED 2 to BL2. If not used, connect BL2 to OUT.
12	BL3	Backlight LED 3 current sink/channel. BL3 controls the current through backlight LED 3. Connect the cathode of backlight LED 3 to BL3. If not used, connect BL3 to OUT.
13	BL4	Backlight LED 4 current sink/channel. BL4 controls the current through backlight LED 4. Connect the cathode of backlight LED 4 to BL4. If not used, connect BL4 to OUT.
14	FL1	Flash LED 1 current sink/channel. FL1 controls the current through flash LED 1. Connect the cathode of flash LED 1 to FL1. If not used, connect FL1 to OUT.
15	FL2	Flash LED 2 current sink/channel. FL2 controls the current through flash LED 2. Connect the cathode of flash LED 2 to FL2. If not used, connect FL2 to OUT.
16	PGND	Power ground. Connect PGND to AGND at a single point as close to the AAT2848 as possible.
17	C2-	Negative terminal of charge pump capacitor 2.
18	C1-	Negative terminal of charge pump capacitor 1.
19	IN	Power input. Connect IN to the input source voltage. Bypass IN to PGND with a 4.7μF or larger ceramic capacitor as close to the AAT2848 as possible.
20	C1+	Positive terminal of charge pump capacitor 1. Connect a 1μF charge pump capacitor 1 from C1+ to C1-.
EP		Exposed paddle (bottom). Connect to ground as close as possible to the device.

## Pin Configuration

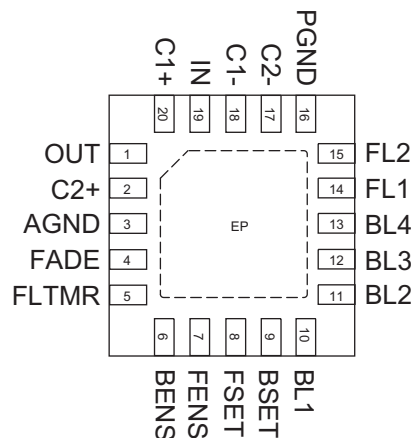

**ChargePump™ High-Current Charge Pump For Backlight Display and Flash Applications**
**Absolute Maximum Ratings<sup>1</sup>**

Symbol	Description	Value	Units
$V_N$	IN, OUT, BL1, BL2, BL3, BL4, FL1, FL2, C1-, C2- Voltage to GND	-0.3 to 6.0	V
$V_N$	C1+, C2+ Voltage to GND	-0.3 to $V_{OUT} + 0.3$	V
$V_N$	BENS, FENS, BSET, FSET, FLTMR, FADE Voltage to GND	-0.3 to $V_{IN} + 0.3$	V
$T_J$	Operating Junction Temperature Range	-40 to 150	°C
$T_{LEAD}$	Maximum Soldering Temperature (at leads, 10 sec)	300	°C

**Thermal Information<sup>2, 3, 4</sup>**

Symbol	Description	Value	Units
$P_D$	Maximum Power Dissipation	2.0	W
$\theta_{JA}$	Maximum Thermal Resistance	50	°C/W

1. Stresses above those listed in Absolute Maximum Ratings may cause permanent damage to the device. Functional operation at conditions other than the operating conditions specified is not implied. Only one Absolute Maximum Rating should be applied at any one time.
2. Based on long-term current density limitation.
3. Derate 20mW/°C above 25°C ambient temperature.
4. Mounted on a 1.6mm-thick FR4 circuit board.

**ChargePump™ High-Current Charge Pump For Backlight Display and Flash Applications**
**Electrical Characteristics<sup>1</sup>**

$V_{IN} = 3.6V$ ;  $C_{IN} = 4.7\mu F$ ;  $C_{OUT} = 2.2\mu F$ ;  $C1 = C2 = 1\mu F$ ;  $R_{BSET} = 15k\Omega$ ;  $R_{FSET} = 14.3k\Omega$ ;  $C_{FLTM R} = 0.33\mu F$ ;  $C_{FADE} = 47nF$ ;  $T_A = -40^{\circ}C$  to  $+85^{\circ}C$ , unless otherwise noted. Typical values are  $T_A = 25^{\circ}C$ .

Symbol	Description	Conditions	Min	Typ	Max	Units
$V_{IN}$	IN Operating Voltage Range		2.7		5.5	V
$I_{IN(Q)}$	IN Operating Current	BENS = IN, FENS = AGND, BL1 = BL2 = BL3 = BL4 = OUT (Excluding LED Current)			600	$\mu A$
		BENS = IN, FENS = AGND, BL1 = BL2 = BL3 = BL4 = OPEN (1.5x CP, no load)			5.5	mA
		BENS = AGND, FENS = IN, FL1 = FL2 = OUT (Excluding LED Current)			600	$\mu A$
		BENS = AGND, FENS = IN, FL1 = FL2 = OPEN (2x CP, no load)			5.5	mA
$I_{IN(SHDN)}$	IN Shutdown Current	BENS = FENS = AGND			1.0	$\mu A$
$T_{SD}$	Thermal Shutdown			140		$^{\circ}C$
$T_{SD(HYS)}$	Thermal Shutdown Hysteresis			15		$^{\circ}C$
<b>Charge Pump Section</b>						
$I_{OUT(MAX)}$	CP Maximum Output Current	IN = 3V	720			mA
$V_{IN(TH,H)}$	Charge Pump Mode Transition Hysteresis	BENS = DATA1		100		mV
$f_{OSC}$	Charge Pump Oscillator Frequency (1.5X mode)	$T_A = 25^{\circ}C$		1.0		MHz
$t_{SS}$	Charge Pump Soft Start Time			100		$\mu s$
<b>BL1-BL4 Backlight LED Outputs</b>						
$I_{BL_(MAX)}$	BL1-BL4 Current Accuracy	BENS = DATA1; $V_{IN} - V_F = 1.5V$	18	20	22	mA
		BENS = DATA32; $V_{IN} - V_F = 1.5V$	0.26	0.32	0.39	
$\Delta I_{(BL_)}$	BL1-BL4 Current Matching	BENS = DATA1; $V_{IN} - V_F = 1.5V$		$\pm 3$		%
$V_{BL_(TH)}$	BL1-BL4 Charge Pump Mode Transition Threshold	Any backlight current sink/channel BL1, BL2, BL3, BL4		120		mV
<b>FL1-FL2 Flash LED Outputs</b>						
$I_{FL_(MAX)}$	FL1-FL2 Current Accuracy	FENS = DATA1; $V_{IN} - V_F = 1.5V$	180	200	220	mA
		FENS = DATA16; $V_{IN} - V_F = 1.5V$	5.66	6.66	7.66	
$\Delta I_{(FL_)}$	FL1-FL2 Current Matching	FENS = DATA1; $V_{IN} - V_F = 1.5V$		$\pm 3$		%
$V_{FL_(TH)}$	FL1-FL2 Charge Pump Mode Transition Threshold	Any flash current sink/channel FL1, FL2		300		mV



**ChargePump™ High-Current Charge Pump For Backlight Display and Flash Applications**
**Electrical Characteristics<sup>1</sup>**

$V_{IN} = 3.6V$ ;  $C_{IN} = 4.7\mu F$ ;  $C_{OUT} = 2.2\mu F$ ;  $C1 = C2 = 1\mu F$ ;  $R_{BSET} = 15k\Omega$ ;  $R_{FSET} = 14.3k\Omega$ ;  $C_{FLTMR} = 0.33\mu F$ ;  $C_{FADE} = 47nF$ ;  $T_A = -40^\circ C$  to  $+85^\circ C$ , unless otherwise noted. Typical values are  $T_A = 25^\circ C$ .

Symbol	Description	Conditions	Min	Typ	Max	Units
<b>BENS and FENS Logic Control</b>						
$V_{BENS(L)}, V_{FENS(L)}$	BENS, FENS Input Low Threshold Voltage				0.4	V
$V_{BENS(H)}, V_{FENS(H)}$	BENS, FENS Input High Threshold Voltage		1.4			V
$I_{BENS}, I_{FENS}$	BENS, FENS Input Leakage Current	$V_{BENS} = V_{FENS} = V_{IN} = 5V$	-1		1	$\mu A$
$t_{FADE}$	Automatic Fade-In/Out Timer	BENS Transition High-to-Low or Low-to-High; DATA1		2.7		s
$t_{FLASH}$	Automatic Flash Disable Time	FENS Transition Low-to-High		1.3		s
$t_{BENS(LOW)}, t_{FENS(LOW)}$	BENS, FENS Low Time		0.3		75	$\mu s$
$t_{BENS(HI\_MIN)}, t_{FENS(HI\_MIN)}$	Minimum BENS, FENS High Time			50		ns
$t_{BENS(HI\_MAX)}, t_{FENS(HI\_MAX)}$	Maximum BENS, FENS High Time				75	$\mu s$
$t_{BENS(OFF)}, t_{FENS(OFF)}$	BENS, FENS Off Timeout				500	$\mu s$
$t_{BENS(LAT)}, t_{FENS(LAT)}$	BENS, FENS Latch Timeout				500	$\mu s$

## Typical Characteristics

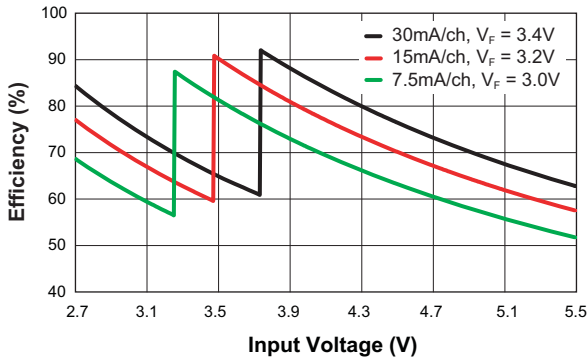
**Backlight Efficiency vs. Input Voltage**



**Backlight Current Matching vs. Temperature**  
(V<sub>IN</sub> = 3.6V; 30mA/Channel)

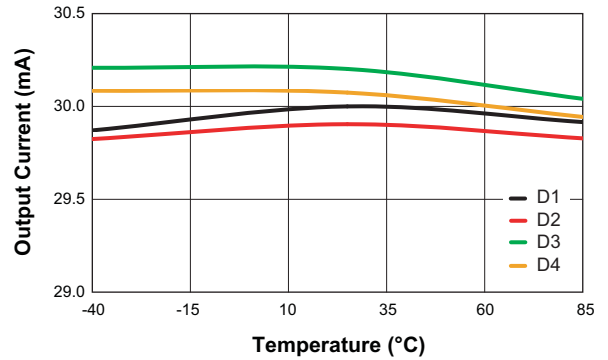

**Flash Efficiency vs. Input Voltage**

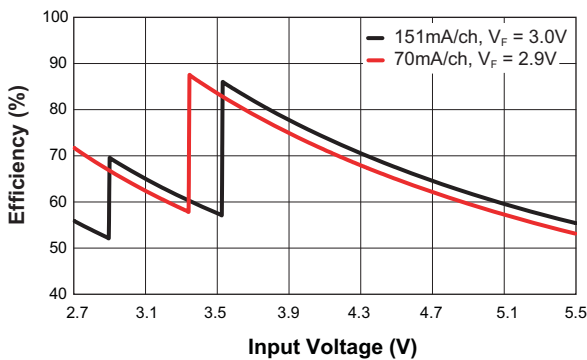

**Flash Current Matching vs. Temperature**  
(V<sub>IN</sub> = 3.6V; 150mA/Channel)

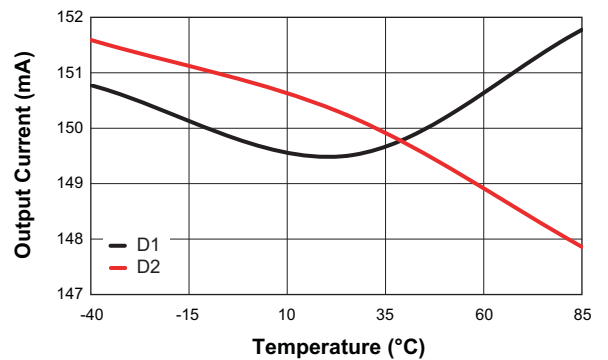

**Turn-On to 1x Mode Backlight**  
(V<sub>IN</sub> = 4.5V; 30mA/Channel)

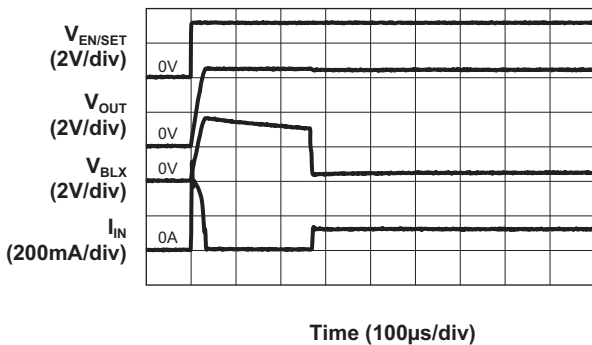

**Turn-On to 1.5x Mode Backlight**  
(V<sub>IN</sub> = 3.6V; 30mA/Channel)

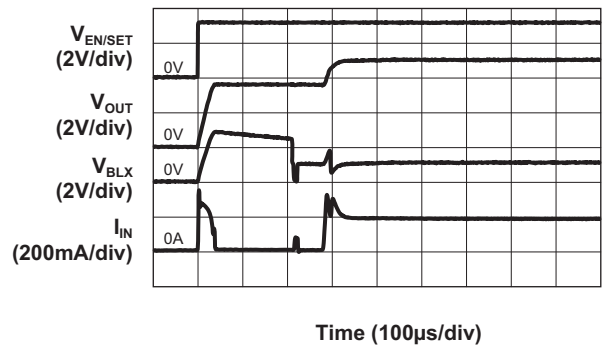

**Typical Characteristics**

**Turn-On to 2x Mode Flash**  
( $V_{IN} = 2.8V$ ; 151mA/Channel)

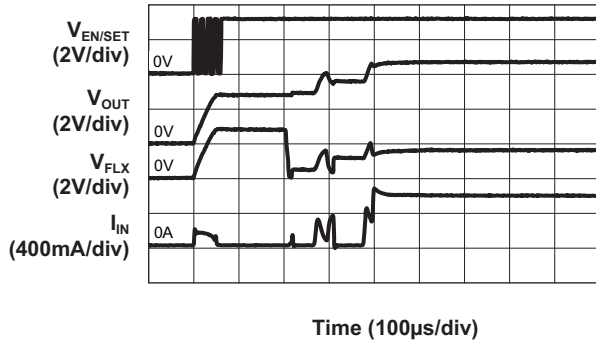

**Turn-On to 1.5x Mode Flash**  
( $V_{IN} = 3.6V$ ; 151mA/Channel)

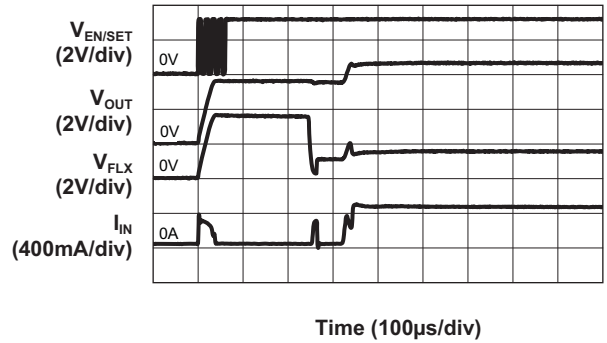

**Turn-Off from 1.5x Mode Backlight**  
( $V_{IN} = 3.6V$ ; 30mA/Channel; Fade-In/Out Disabled)

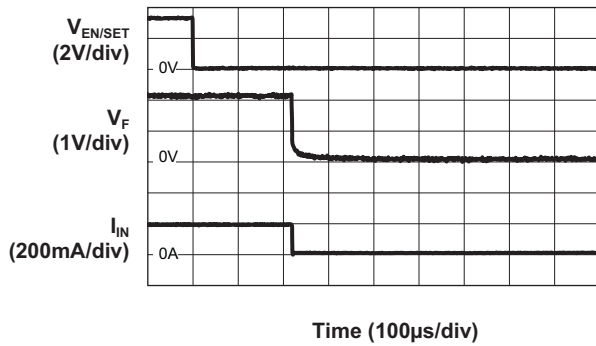

**Turn-Off from 1.5x Mode Flash**  
( $V_{IN} = 3.6V$ ; 151mA/Channel)

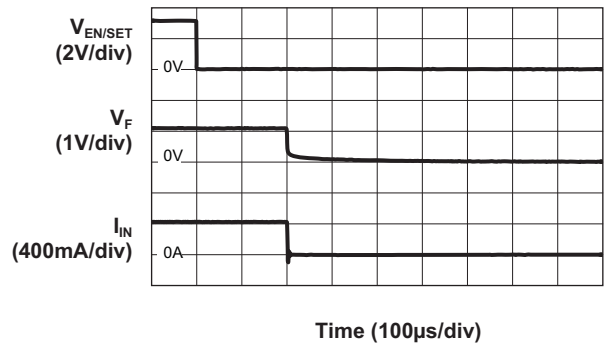

**Turn-Off from 2x Mode Flash**  
( $V_{IN} = 2.8V$ ; 151mA/Channel)

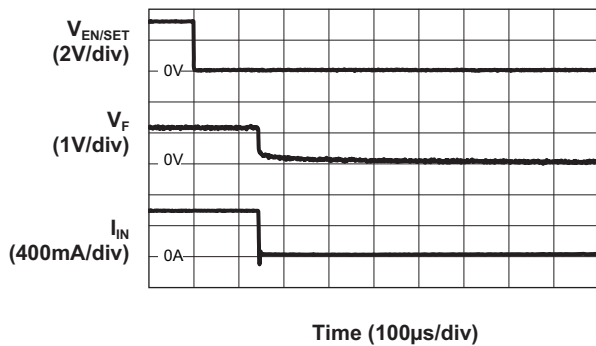

**Backlight Operating Characteristics**  
( $V_{IN} = 3.6V$ ; 1.5x Mode; 30mA/Channel; AC Coupled)

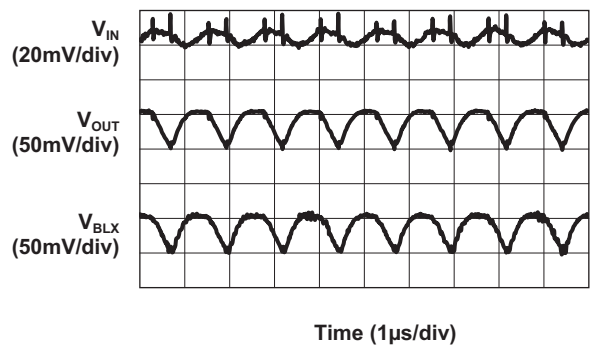

## Typical Characteristics

### Backlight Operating Characteristics

( $V_{IN} = 3.6V$ ; 1.5x Mode; 15mA/Channel; AC Coupled)

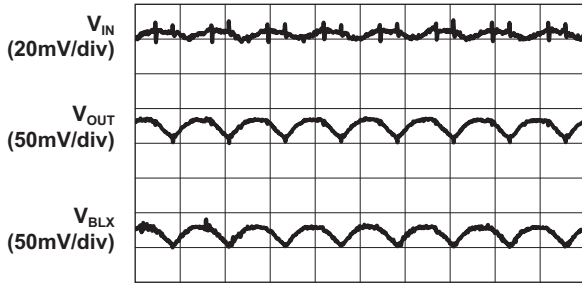

Time (1 $\mu$ s/div)

### Flash Operating Characteristics

( $V_{IN} = 3.6V$ ; 1.5x Mode; 151mA/Channel; AC Coupled)

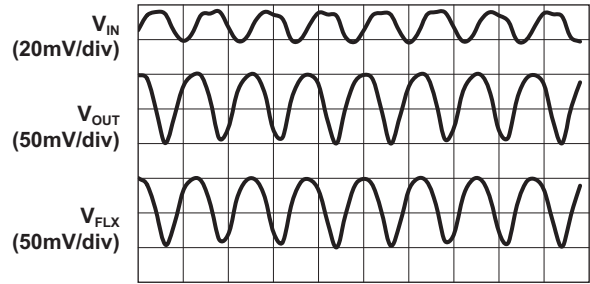

Time (1 $\mu$ s/div)

### Flash Operating Characteristics

( $V_{IN} = 3.3V$ ; 1.5x Mode; 70mA/Channel; AC Coupled)

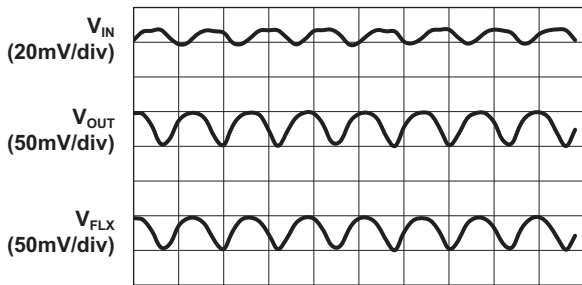

Time (1 $\mu$ s/div)



## Functional Block Diagram

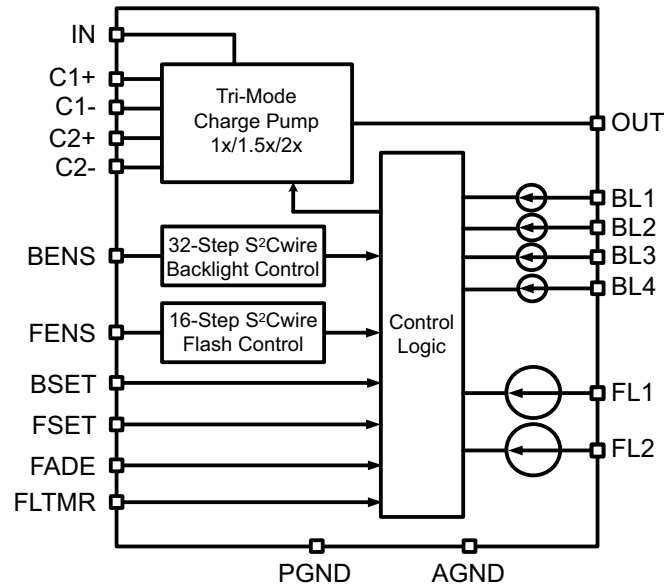

## Functional Description

The AAT2848 is an integrated solution for LCD display applications with a built-in four-channel, 30mA driver for white LED backlight and two 300mA drivers for flash LEDs.

The backlight driver uses a dual-mode load switch (1x) and high-efficiency (1.5x) charge-pump engine. To maximize power conversion efficiency, an internal sensing circuit monitors the voltage required on each constant current sink output and sets the load switch and charge pump mode based on the input battery voltage and the current sink input voltage. As the battery discharges over time, the charge pump is enabled when any of the four current sink inputs nears dropout. The charge pump operates in 1.5x mode for backlight operation. The charge pump requires only four external components: two 1 $\mu$ F ceramic capacitors for the charge pump flying capacitors (C1 and C2), one 4.7 $\mu$ F ceramic input capacitor (C<sub>IN</sub>) and one 2.2 $\mu$ F ceramic charge pump output capacitor (C<sub>OUT</sub>).

The four constant current sink inputs (BL1 to BL4) can drive up to four individual LEDs with a maximum current of 30mA each. Because the inputs BL1 to BL4 are true independent constant current sinks, the voltage observed on any single given input will be determined by the difference between V<sub>OUT</sub> and the actual forward voltage (V<sub>F</sub>) of the LED being driven.

Any unused sink inputs must be connected to the OUT pin; otherwise, the AAT2848 will operate in 1.5x charge pump mode regardless of the battery voltage or the V<sub>F</sub> of the diodes connected to the remaining current sinks. The S<sup>2</sup>Cwire serial interface at the BENS input enables the charge pump and sets the backlight current sink level.

Since the current level is programmable, no PWM (pulse width modulation) or additional control circuitry is needed to control LED brightness. This feature greatly reduces the burden on a microcontroller or system IC to manage LED or display brightness, allowing the user to "set it, and forget it." With its high speed serial interface (>1MHz data rate), the LED current drive can be changed successively to brighten or dim the LEDs in smooth transitions or in abrupt steps, giving the user complete programmability and real-time control of LED brightness.

The flash driver uses a tri-mode load switch (1x) and high-efficiency (1.5x and 2x) charge-pump engine. To maximize power conversion efficiency, an internal sensing circuit monitors the voltage required on each constant flash current sink/channel input and sets the load switch and charge pump mode based on the input battery voltage and the flash current sink input voltage. As the battery discharges over time, the charge pump is enabled when any of the two flash current sink inputs nears dropout. The charge pump initially starts in 1.5x mode, and then transitions into 2x mode if the flash current sink inputs nears dropout.

## ChargePump™ High-Current Charge Pump For Backlight Display and Flash Applications

The two constant flash current sink outputs (FL1 and FL2) can drive up to two LEDs with a maximum current of 300mA each. Because the outputs FL1 and FL2 are true independent constant flash current sinks, the voltage observed on any single given output will be determined by the difference between  $V_{OUT}$  and the actual forward voltage ( $V_F$ ) of the flash LED being driven.

Any unused flash sink inputs must be connected to the OUT pin; otherwise, the AAT2848 will operate continuously in 2x charge pump mode regardless of the battery voltage or  $V_F$  of the remaining diodes connected to the current sinks. The S<sup>2</sup>Cwire serial interface at the FENS input enables the charge pump and sets the flash current sink levels.

The backlight and flash LED currents are controlled by a combination of an external programming resistor from BSET (for backlight) or FSET (for flash) to AGND and the backlight or flash serial S<sup>2</sup>Cwire interface BENS or FENS. The programming resistor sets the maximum LED current for each channel, and the serial S<sup>2</sup>Cwire interface controls the LED current relative to the maximum.

For backlight LEDs, the maximum channel current can be set up to 30mA with a 10k $\Omega$  resistor connected at the BSET pin of the AAT2848. Depending upon the application and the white LEDs chosen, the preferred and most accurate method for a backlight LED current control is to choose  $R_{BSET}$  for the maximum backlight current required by the application conditions and use the S<sup>2</sup>Cwire control to set the backlight current to lower levels. The 32 levels provided by the interface allows a smooth transition between intermediate values. Table 1 and Figure 1 illustrate the current magnitude control from the S<sup>2</sup>Cwire interface at the BENS pin, based on the maximum current set by the  $R_{BSET}$  resistor.

For flash white LEDs, the maximum channel current can be set up to 300mA with a 9.53k $\Omega$  resistor connected at the FSET pin of the AAT2848. Depending upon the application and the flash white LEDs chosen, the preferred method for flash LED current control is to choose  $R_{FSET}$  for the maximum flash current required by the application conditions; use the S<sup>2</sup>Cwire control to set the backlight current to lower levels. Table 2 and Figure 2 illustrate the current magnitude control from the S<sup>2</sup>Cwire interface at the FENS pin, based on the maximum current set by the  $R_{FSET}$  resistor.

BENS Data	$I_{BLX}$ (%)	$R_{BSET}$ ( $\Omega$ )
1	100	15k (20mA Max)
2	97	
3	93	
4	90	
5	87	
6	83	
7	80	
8	77	
9	73	
10	70	
11	67	
12	63	
13	60	
14	57	
15	54	
16	51	
17	47	
18	44	
19	41	
20	38	
21	35	
22	32	
23	28	
24	25	
25	22	
26	19	
27	16	
28	13	
29	10	
30	7	
31	3	
32	1.5	

**Table 1:  $I_{BLX}$  (%) vs. BENS Data.**

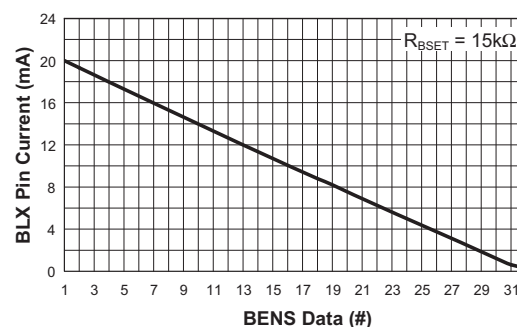
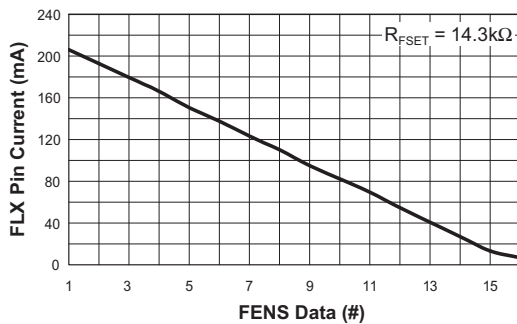

**Figure 1: BL1-BL4 Current Control Profile.**

## ChargePump™ High-Current Charge Pump For Backlight Display and Flash Applications

FENS Data	I <sub>FLX</sub> (%)	R <sub>FSET</sub> (Ω)	FENS Data	I <sub>FLX</sub> (%)	R <sub>FSET</sub> (Ω)
1	100	14.3k (206mA Max)	9	46	14.3k (206mA Max)
2	94		10	40	
3	87		11	34	
4	81		12	27	
5	73		13	20	
6	67		14	13	
7	60		15	6	
8	53		16	3	

**Table 2: I<sub>FLX</sub> (%) vs. FENS Data.**



**Figure 2: FL1-FL2 Current Control Profile.**

### S<sup>2</sup>Cwire Serial Interface

The S<sup>2</sup>Cwire single-wire serial interface used in the AAT2848 exhibits flexible timing in that data can be clocked-in at speeds ranging from 15kHz to higher than 1MHz.

The S<sup>2</sup>Cwire serial interface recognizes rising edges at both the BENS pin and at the FENS pin. For setting the backlight current level, data applied at the AAT2848's BENS input is decoded into 32 different levels. For setting the flash current level, data applied at the AAT2848's FENS input is decoded into 16 different levels. After data is supplied, the BENS and the FENS inputs pins are held high to latch the data.

Once the data at BENS or FENS has been held in the logic high state for longer than t<sub>LAT</sub> (500µs), the programmed backlight or flash current becomes active and the internal backlight and flash data registers are latched. To adjust the backlight and/or flash current levels once programmed, the requisite number of rising edges corresponding to the desired code must be applied at the BENS or the FENS pin.

The AAT2848 features separate control interfaces for backlight and flash current control. The backlight current features 32 current steps, each step as a percentage of the maximum backlight current set by the BSET resistor.

The flash has 16 current level settings; again, each step as a percentage of the maximum flash current set by the FSET resistor.

### Flash Timeout Functionality

The AAT2848 contains an internal flash mode operation timeout safety circuit. The purpose of this timeout circuit is to prevent any thermal damage to the flash white LED when flash mode operation is unable to be disabled by the embedded microprocessor/microcontroller. Flash mode operation is initiated by strobing the FENS pin low-to-high, this also initiates the flash timer circuit which can be programmed via an external capacitor at the FLTMR pin. The flash timeout period can be calculated using the following equation:

$$\text{Flash Timeout} = 3.9 \text{ s}/\mu\text{F} \cdot C_{\text{FLTMR}}$$

where Flash Timeout is in seconds and C<sub>FLTMR</sub> is in µF. For example, for a 0.33µF capacitor:

$$\text{Flash Timeout} = 3.9 \text{ s}/\mu\text{F} \cdot 0.33\mu\text{F} = 1.3\text{s}$$

To disable the flash timer, connect the FLTMR pin to AGND.

When both the BENS and the FENS inputs are strobed and held low for longer than t<sub>OFF</sub> (500µs), the AAT2848 enters shutdown mode and draws less than 1µA from V<sub>IN</sub>. Both internal backlight and flash data registers are cleared to zero when in shutdown.

### Backlight/Flash LED Current Setting

The maximum backlight and flash LED currents are set, or programmed, with external resistors. The backlight LED current is programmed by the R<sub>BSET</sub> resistor with the following equation:

$$R_{\text{BSET}} = \frac{300}{I_{\text{BLED}}}$$

R<sub>BSET</sub> = Backlight LED Current Programming Resistor  
I<sub>BLED</sub> = Backlight LED Current

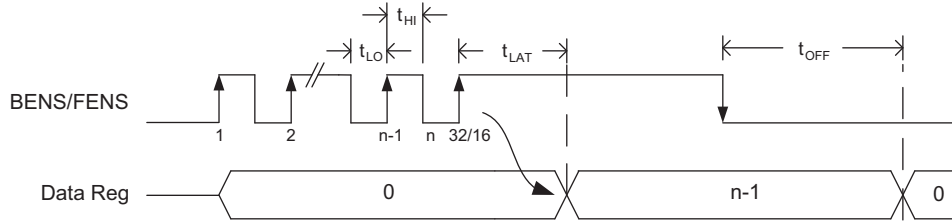

**Figure 3: S²Cwire Serial Interface Timing.**

The flash LED current is programmed by the  $R_{FSET}$  resistor with the following equation:

$$R_{FSET} = \frac{2880}{I_{FLED}}$$

$R_{FSET}$  = Flash LED Current Programming Resistor  
 $I_{FLED}$  = Flash LED Current

### Backlight Fade-In/ Fade-Out Functionality

The AAT2848 contains internal circuitry that automates fade-in/fade-out operation. Fade functionality simply allows for the turning off/on of the LEDs in a smooth controlled transition. The AAT2848 does not have to be manually programmed to avoid the abrupt changes in lighting when white LED drivers are shutdown/turned-off. The fade-in/fade-out operation occurs only during device on/off transitions. The response time is constant regardless of the LED current level.

The backlight fade-in/fade-out response time ( $t_{FADE}$ ) can be calculated using the following equation:

$$t_{FADE} = 57 \text{ s}/\mu\text{F} \cdot C_{FADE}$$

where  $t_{FADE}$  is in seconds and  $C_{FADE}$  is in  $\mu\text{F}$ . For example, for a  $0.047\mu\text{F}$  capacitor:

$$t_{FADE} = 57 \text{ s}/\mu\text{F} \cdot 0.047\mu\text{F} = 2.7\text{s}$$

To disable the fade-in/fade-out timer, connect the FADE pin to IN.

### Auto Disable Feature

The charge pump in AAT2848 is equipped with an auto-disable feature for each LED channel. After the IC is enabled and started up, a test current of 1.5mA (typical) is forced through each sink channel. The channel will be disabled if the voltage of that particular BLX or FLX pin does not drop to a certain threshold. This feature is convenient for disabling an unused channel or during a flash/backlight LED failed short event.

### Thermal Protection

The charge pump has a built-in thermal protection circuit that will shut down the charge pump if the die temperature rises above the thermal limit as is the case during a short circuit of the OUT pin.

## Applications Information

### LED Selection

The AAT2848 is specifically intended for driving white LEDs. However, the device design will allow the AAT2848 to drive most types of LEDs. LED applications may include mixed arrangements for display backlighting, color (RGB) LEDs, infrared (IR) diodes and any other load needing a constant current source generated from a varying input voltage. Since the BL1 to BL4 and FL1 to FL2 constant current sinks are matched with negligible voltage dependence, the constant current channels will be matched regardless of the specific LED forward voltage ( $V_F$ ) levels.

The low-dropout current sinks in the AAT2848 maximize performance and make it capable of driving LEDs with high forward voltages. Multiple channels can be combined to obtain a higher LED drive current without complication.

### Device Switching Noise Performance

The AAT2848 operates at a fixed frequency of approximately 1MHz to control noise and limit harmonics that can interfere with the RF operation of cellular telephone handsets or other communication devices. Back-injected noise appearing on the input pin of the charge pump is 20mV peak-to-peak, typically ten times less than inductor-based DC/DC boost converter white LED backlight solutions. The AAT2848 soft-start feature prevents noise transient effects associated with in-rush currents during the start up of the charge pump circuit.

### Power Efficiency and Device Evaluation

Charge-pump efficiency discussion in the following sections accounts only for the efficiency of the charge pump section itself. Due to the unique circuit architecture and design of the AAT2848, it is very difficult to measure efficiency in terms of a percent value comparing input power over output power.

Since the AAT2848 outputs are pure constant current sinks/channels and typically drive individual loads, it is difficult to measure the output voltage for a given output (BL1 to BL4 and FL1 to FL2) to derive an overall output power measurement. For any given application, white LED forward voltage levels can differ, yet the output drive current will be maintained as a constant.

This makes quantifying output power a difficult task when taken in the context of comparing to other white LED driver circuit topologies. A better way to quantify total device efficiency is to observe the total input power to the device for a given LED current drive level. The best white LED driver for a given application should be based on trade-offs of size, external component count, reliability, operating range and total energy usage...*not just "% efficiency."*

### Device Power Efficiency

The AAT2848's backlight charge pump conversion efficiency is defined as the power delivered to the white LED load divided by the input power:

$$\eta = \frac{P_{LEDs}}{P_{IN}} = \frac{V_{LED1} \cdot I_{LED1} + \dots + V_{LEDX} \cdot I_{LEDX}}{V_{IN} \cdot I_{IN}}$$

$V_{LEDX}$  = White LED Forward Voltage ( $V_F$ )

$I_{LEDX}$  = White LED Bias Current ( $I_D$ )

X = Number of Backlight White LEDs

The expression to define the estimated ideal backlight efficiency ( $\eta$ ) for the AAT2848 in 1x mode is as follows:

$$\eta = \frac{P_{LEDs}}{P_{IN}} = \frac{V_{LED1} \cdot I_{LED1} + \dots + V_{LEDX} \cdot I_{LEDX}}{V_{IN} \cdot I_{IN}}$$

$$\eta = \frac{X \cdot V_{LEDX} \cdot I_{LEDX}}{V_{IN} \cdot I_{IN}}; X = 1, 2, 3 \text{ or } 4 \text{ and } I_{IN} = X \cdot I_{LEDX}$$

$$\eta = \frac{V_{LEDX}}{V_{IN}}$$

The AAT2848's backlight charge pump is a fractional charge pump which will boost the input supply voltage in the event where  $V_{IN}$  is less than the required output voltage across the backlight white LED load.

With an ideal 1.5x charge pump, the input current is 1.5x of the output current. The expression to define the estimated ideal backlight efficiency ( $\eta$ ) for the AAT2848 in 1.5x mode is as follows:

$$\eta = \frac{P_{LEDs}}{P_{IN}} = \frac{V_{LED1} \cdot I_{LED1} + \dots + V_{LEDX} \cdot I_{LEDX}}{V_{IN} \cdot I_{IN}}$$

$$\eta = \frac{X \cdot V_{LEDX} \cdot I_{LEDX}}{V_{IN} \cdot I_{IN}}; X = 1, 2, 3 \text{ or } 4 \text{ and } I_{IN} = 1.5(X \cdot I_{LEDX})$$

$$\eta = \frac{V_{LEDX}}{1.5V_{IN}}$$

## ChargePump™ High-Current Charge Pump For Backlight Display and Flash Applications

The AAT2848's flash charge pump conversion efficiency is defined as the power delivered to the flash white LED load divided by the input power:

$$\eta = \frac{P_{LEDs}}{P_{IN}} = \frac{V_{LED1} \cdot I_{LED1} + V_{LED2} \cdot I_{LED2}}{V_{IN} \cdot I_{IN}}$$

$V_{LEDx}$  = White LED Forward Voltage ( $V_F$ )

$I_{LEDx}$  = White LED Bias Current ( $I_D$ )

X = Number of Flash White LEDs

The expression to define the estimated ideal flash efficiency ( $\eta$ ) for the AAT2848 in 1x mode is as follows:

$$\eta = \frac{P_{LEDs}}{P_{IN}} = \frac{V_{LED1} \cdot I_{LED1} + V_{LED2} \cdot I_{LED2}}{V_{IN} \cdot I_{IN}}$$

$$\eta = \frac{X \cdot V_{LEDX} \cdot I_{LEDX}}{V_{IN} \cdot I_{IN}}; X = 1 \text{ or } 2 \text{ and } I_{IN} = X \cdot I_{LEDX}$$

$$\eta = \frac{V_{LEDX}}{V_{IN}}$$

The AAT2848's flash charge pump is a fractional charge pump which will boost the input supply voltage in the event where  $V_{IN}$  is less than the required output voltage across the flash white LED load.

With an ideal 1.5x charge pump, the input current is 1.5x of the output current. The expression to define the estimated ideal flash efficiency ( $\eta$ ) for the AAT2848 in 1.5x mode is as follows:

$$\eta = \frac{P_{LEDs}}{P_{IN}} = \frac{V_{LED1} \cdot I_{LED1} + V_{LED2} \cdot I_{LED2}}{V_{IN} \cdot I_{IN}}$$

$$\eta = \frac{X \cdot V_{LEDX} \cdot I_{LEDX}}{V_{IN} \cdot I_{IN}}; X = 1 \text{ or } 2 \text{ and } I_{IN} = 1.5(X \cdot I_{LEDX})$$

$$\eta = \frac{V_{LEDX}}{1.5V_{IN}}$$

The same calculations apply for the AAT2848 in 2x mode where for an ideal 2x charge pump, the input current is 2x of the output current. The expression for the estimated ideal flash efficiency ( $\eta$ ) for the AAT2848 in 2x mode is as follows:

$$\eta = \frac{P_{LEDs}}{P_{IN}} = \frac{V_{LED1} \cdot I_{LED1} + V_{LED2} \cdot I_{LED2}}{V_{IN} \cdot I_{IN}}$$

$$\eta = \frac{X \cdot V_{LEDX} \cdot I_{LEDX}}{V_{IN} \cdot I_{IN}}; X = 1 \text{ or } 2 \text{ and } I_{IN} = 2(X \cdot I_{LEDX})$$

$$\eta = \frac{V_{LEDX}}{2V_{IN}}$$

### Capacitor Selection

Careful selection of the four most critical external capacitors  $C_{IN}$ , C1, C2, and  $C_{OUT}$  are important because they will affect turn on time, output ripple and transient performance (the flash timeout and fade functionality capacitors are not as critical to the normal operation of the AAT2848). Optimum performance will be obtained when low ESR (<100m $\Omega$ ) ceramic capacitors are used. In general, low ESR is defined as a resistance that is less than 100m $\Omega$ .

X7R and X5R type ceramic capacitors are highly recommended over all other types of capacitors for use with the AAT2848. For the charge pump section, a 1 $\mu$ F or greater capacitor is required for the fly (C1 and C2) capacitors. The required input capacitor ( $C_{IN}$ ) is 4.7 $\mu$ F or greater and the required output capacitor ( $C_{OUT}$ ) is 2.2 $\mu$ F or greater.

Ceramic capacitors offer many advantages over their tantalum and aluminum electrolytic counterparts. A ceramic capacitor typically has very low ESR, is lowest cost, has a smaller printed circuit board (PCB) footprint, and is non-polarized. Low ESR ceramic capacitors maximize charge pump transient response.

Before choosing a particular capacitor, verify the capacitor's performance with the characteristics illustrated in the component's data sheet. Performance verification will help avoid undesirable component related performance deficiencies. Suggested typical ceramic capacitor components for AAT2848 are listed in Table 3.

### PCB Layout

To achieve adequate electrical and thermal performance, careful attention must be given to the PCB layout. In the worst-case operating condition, the chip must dissipate considerable power at full load. Adequate heat-sinking must be achieved to ensure intended operation.

Figures 6 and 7 illustrate an example PCB layout (evaluation board). See Figures 4 and 5 for the accompanying schematic of the evaluation board. The bottom of the package features an exposed metal pad. The exposed

**ChargePump™ High-Current Charge Pump For Backlight Display and Flash Applications**

pad acts, thermally, to transfer heat from the chip and, electrically, as a ground connection.

The junction-to-ambient thermal resistance ( $\theta_{JA}$ ) for the connection can be significantly reduced by following a couple of important PCB design guidelines. The PCB area directly underneath the package should be plated so that the exposed paddle can be mated to the top layer PCB copper during the reflow process. Multiple copper plated thru-holes should be used to electrically and thermally connect the top surface pad area to additional ground plane(s).

The chip ground is internally connected to both the exposed pad and to the AGND and PGND pins. It is good practice to connect the GND pins to the exposed pad area with traces.

The flying capacitors (C1 and C2), input capacitor (C4), and output capacitor (C5) should be connected as close as possible to the IC. In addition to the external passive components being placed as close as possible to the IC, all traces connecting the AAT2848 should be as short and wide as possible to minimize path resistance and potential coupling.

Manufacturer	Part Number	Value	Voltage	Temp. Co.	Case
AVX	0603ZD105K	1 $\mu$ F	10	X5R	0603
	0603ZD225K	2.2 $\mu$ F	10		
TDK	C1608X5R1E105K	1 $\mu$ F	25	X5R	0603
	C1608X5R1C225K	2.2 $\mu$ F	16		
	C1608X5R1A475K	4.7 $\mu$ F	10		
Murata	GRM188R61C105K	1 $\mu$ F	16	X5R	0603
	GRM188R61A225K	2.2 $\mu$ F	10		
Taiyo Yuden	LMK107BJ475KA	4.7 $\mu$ F	10	X5R	0603

**Table 3: Suggested Capacitor Components.**

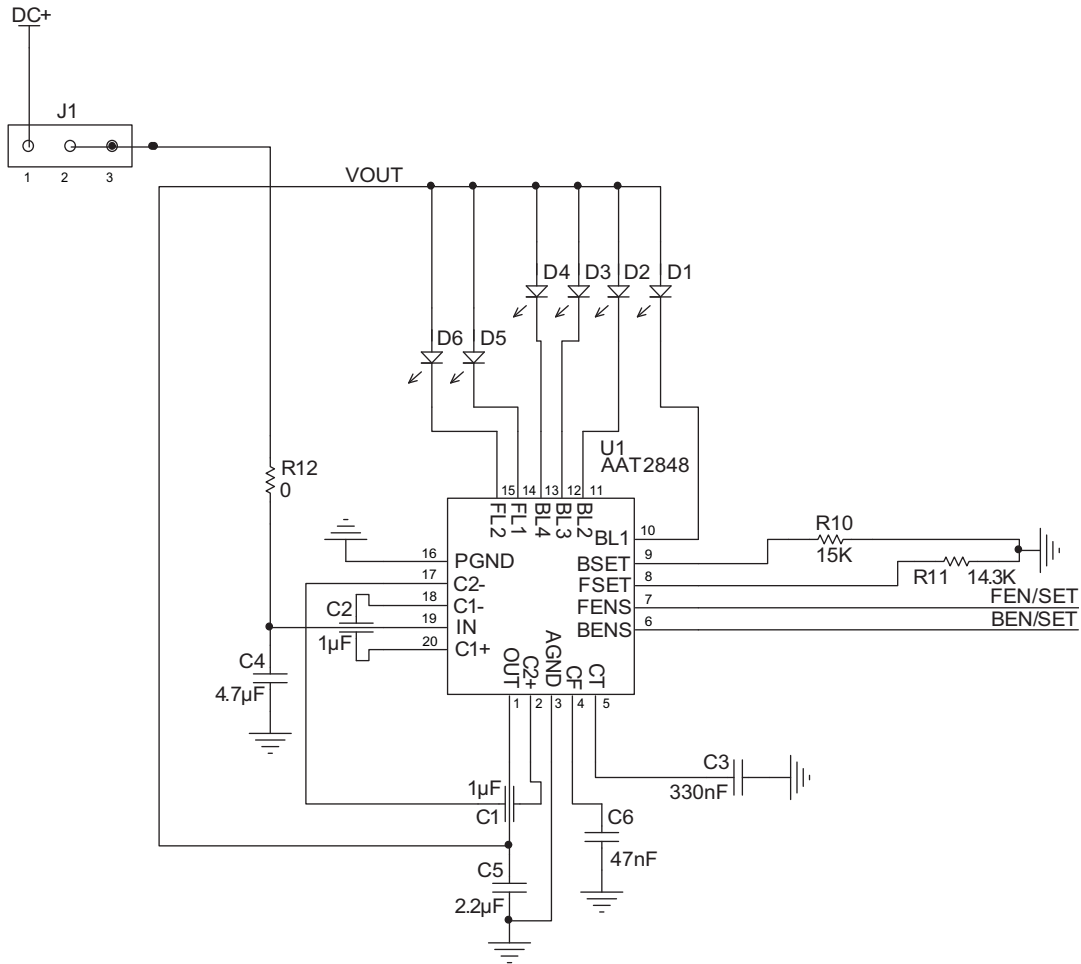

Figure 4: AAT2848 Evaluation Board Schematic.





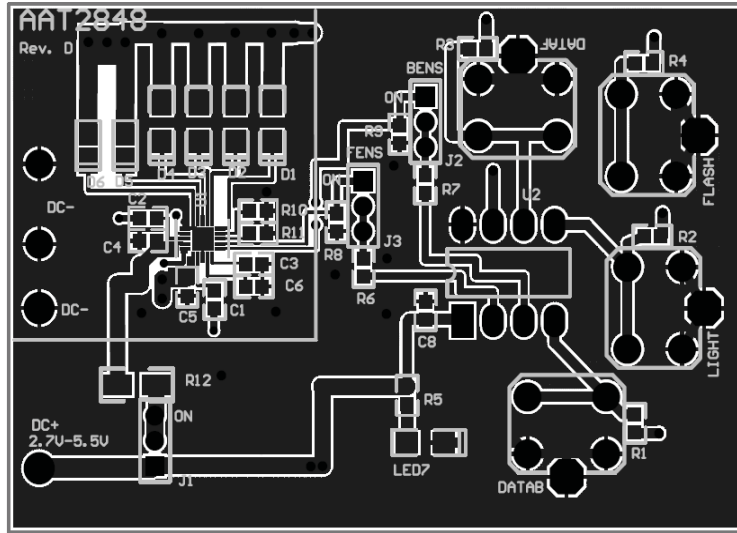

Figure 6: AAT2848 Evaluation Board Top View Layout.

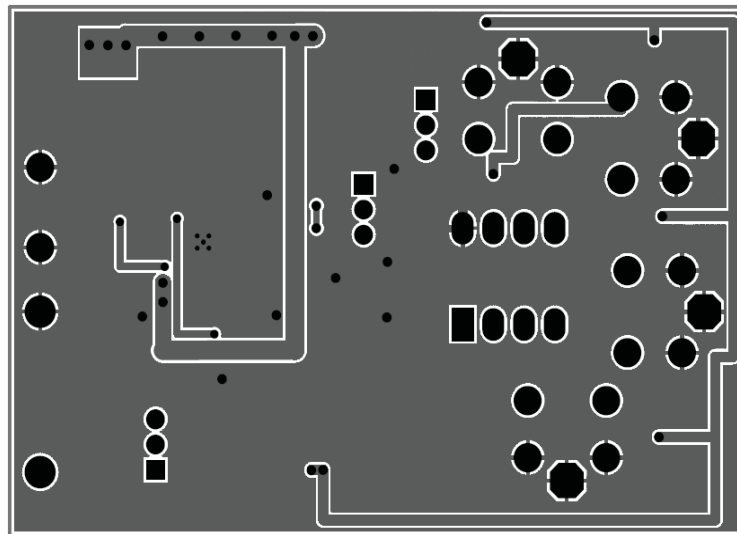

Figure 7: AAT2848 Evaluation Board Bottom View Layout.

## Ordering Information

Package	Marking <sup>1</sup>	Part Number (Tape and Reel) <sup>2</sup>
TQFN33-20	ZPXY	AAT2848IDG-T1



All AnalogicTech products are offered in Pb-free packaging. The term “Pb-free” means semiconductor products that are in compliance with current RoHS standards, including the requirement that lead not exceed 0.1% by weight in homogeneous materials. For more information, please visit our website at <http://www.analogictech.com/about/quality.aspx>.

## Package Information

### TQFN33-20<sup>3</sup>

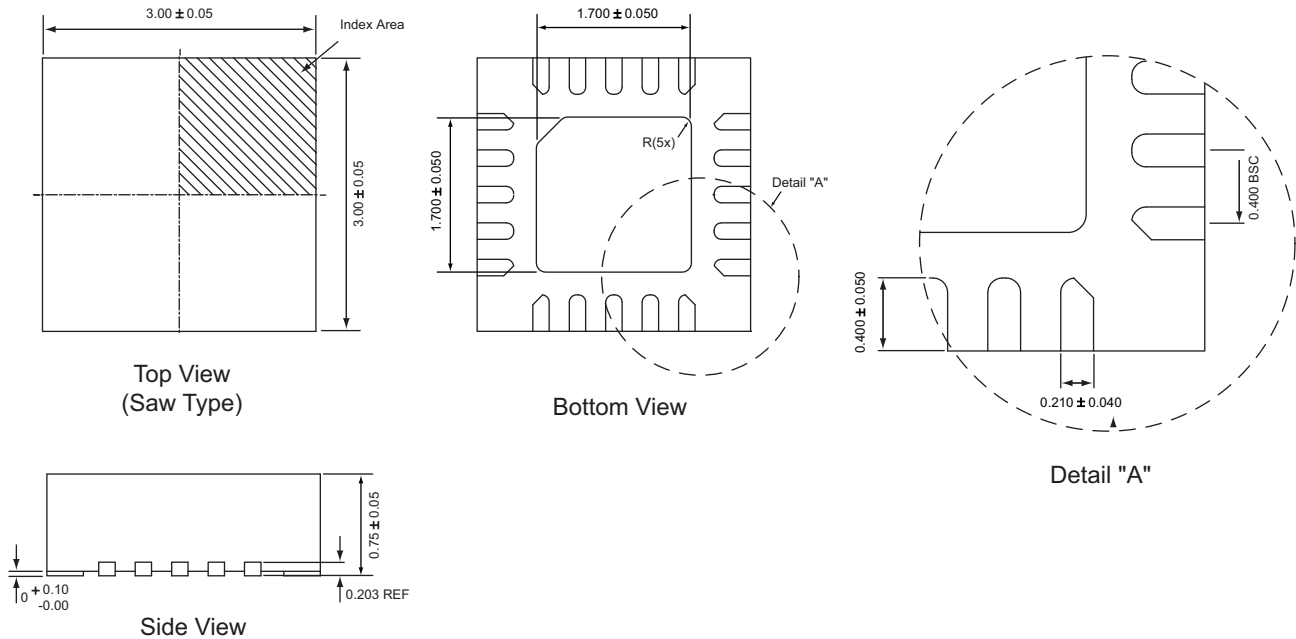

All dimensions in millimeters.

1. XYY = assembly and date code.
2. Sample stock is generally held on part numbers listed in **BOLD**.
3. The leadless package family, which includes QFN, TQFN, DFN, TDFN, and STDFN, has exposed copper (unplated) at the end of the lead terminals due to the manufacturing process. A solder fillet at the exposed copper edge cannot be guaranteed and is not required to ensure a proper bottom solder connection.

**Advanced Analogic Technologies, Inc.**  
 3230 Scott Boulevard, Santa Clara, CA 95054  
 Phone (408) 737-4600  
 Fax (408) 737-4611



© Advanced Analogic Technologies, Inc. AnalogicTech cannot assume responsibility for use of any circuitry other than circuitry entirely embodied in an AnalogicTech product. No circuit patent licenses, copyrights, mask work rights, or other intellectual property rights are implied. AnalogicTech reserves the right to make changes to their products or specifications or to discontinue any product or service without notice. Except as provided in AnalogicTech's terms and conditions of sale, AnalogicTech assumes no liability whatsoever, and AnalogicTech disclaims any express or implied warranty relating to the sale and/or use of AnalogicTech products including liability or warranties relating to fitness for a particular purpose, merchantability, or infringement of any patent, copyright or other intellectual property right. In order to minimize risks associated with the customer's applications, adequate design and operating safeguards must be provided by the customer to minimize inherent or procedural hazards. Testing and other quality control techniques are utilized to the extent AnalogicTech deems necessary to support this warranty. Specific testing of all parameters of each device is not necessarily performed. AnalogicTech and the AnalogicTech logo are trademarks of Advanced Analogic Technologies Incorporated. All other brand and product names appearing in this document are registered trademarks or trademarks of their respective holders.